

# WLC Precision Balances

Standard weighing and mobility for majority of laboratory and industrial applications



WLC F1/R  
direct indicator-platform connection



WLC F1/K  
1 m cable connection





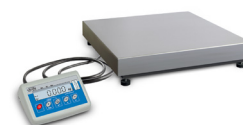







WLC C2/R  
direct indicator-platform connection



WLC C2/K  
2.5 m cable connection

## Functions

- |   |  |  |   |  |
|---|--|--|---|--|
|  Parts counting |  Percent weighing |  Totalizing   |  In-built battery |  Replaceable unit |
|  +/- Control    |  Peak hold        |  Alibi memory |  Real-time clock  |  Tare memory      |

## Features

### Measurements Accuracy and Performance

Measurement accuracy and robust design of the WLC balances enable precise mass determination under laboratory and industrial conditions.

### Fast Measurement and Uncomplicated Operation

Easy operation enables fast and reliable measurements to be carried out even by an inexperienced operator.

### Clearly Presented Indications

Simple and easy-to-read LCD display assures clear presentation of the weighing result under various working conditions.

### Mobility Due to an Internal Battery

In addition to power supply from the mains, the WLC balances are equipped with an external battery that enables several hours long mobile operation.

### Numerous Variants of Weighing Pan Dimensions

Numerous variants of weighing pan dimensions enable selecting the best weighing instrument suiting specific requirements and needs.

### Wide Capacity Range for Different Applications

Due to an exceptionally wide range of capacities it is possible to work with samples of different weight, from few grams to even over one hundred kilograms.

## Technical Specifications

	WLC 1/A2	WLC 2/A2	WLC 6/A2	WLC 10/A2	WLC 20/A2
<b>Maximum capacity [Max]</b>	1 kg	2 kg	6 kg	10 kg	20 kg
<b>Minimum load</b>	—	—	5 g	—	—
<b>Readability [d]</b>	0.01 g	0.01 g	0.1 g	0.1 g	0.1 g
<b>Verification scale interval [e]</b>	—	—	1 g	—	—
<b>Tare range</b>	-1 kg	-2 kg	-6 kg	-10 kg	-20 kg
<b>Repeatability*</b>	0.01 g	0.01 g	0.1 g	0.1 g	0.1 g
<b>Linearity</b>	±0.03 g	±0.03 g	±0.2 g	±0.3 g	±0.3 g
<b>Stabilization time</b>	3 s	3 s	3 s	3 s	3 s
<b>Adjustment</b>	external (2 stages)	external (2 stages)	—	external (2 stages)	external (2 stages)
<b>Verification</b>	—	—	Yes	—	—
<b>OIML Class</b>	—	—	II	—	—
<b>Display</b>	LCD (with backlight)	LCD (with backlight)	LCD (with backlight)	LCD (with backlight)	LCD (with backlight)
<b>Keypad</b>	6 keys	6 keys	6 keys	6 keys	6 keys
<b>Protection class</b>	IP 43	IP 43	IP 43	IP 43	IP 43
<b>USB-A</b>	1	1	1	1	1
<b>USB-B</b>	1	1	1	1	1
<b>RS 232</b>	2	2	2	2	2
<b>IN/OUT**</b>	4 × IN, 4 × OUT	4 × IN, 4 × OUT	4 × IN, 4 × OUT	4 × IN, 4 × OUT	4 × IN, 4 × OUT
<b>Power consumption</b>	6 W	6 W	6 W	6 W	6 W
<b>Power supply</b>	100 ÷ 240 V AC 50 ÷ 60 Hz / 12 V DC + battery	100 ÷ 240 V AC 50 ÷ 60 Hz / 12 V DC + battery	100 ÷ 240 V AC 50 ÷ 60 Hz / 12 V DC + battery	100 ÷ 240 V AC 50 ÷ 60 Hz / 12 V DC + battery	100 ÷ 240 V AC 50 ÷ 60 Hz / 12 V DC + battery
<b>Operation time on batteries</b>	15 h	15 h	15 h	15 h	15 h
<b>Operating temperature</b>	+15 ÷ +30 °C	+15 ÷ +30 °C	+15 ÷ +30 °C	+15 ÷ +30 °C	+15 ÷ +30 °C
<b>Atmospheric humidity***</b>	10 ÷ 85% RH	10 ÷ 85% RH	10 ÷ 85% RH	10 ÷ 85% RH	10 ÷ 85% RH
<b>Weighing pan dimensions</b>	195 × 195 mm	195 × 195 mm	195 × 195 mm	195 × 195 mm	195 × 195 mm
<b>Weighing device dimensions</b>	333 × 206 × 97 mm	333 × 206 × 97 mm	333 × 206 × 97 mm	333 × 206 × 97 mm	333 × 206 × 97 mm
<b>Net weight</b>	2.8 kg	2.8 kg	2.8 kg	2.8 kg	2.8 kg
<b>Gross weight</b>	4.3 kg	4.3 kg	4.3 kg	4.3 kg	4.3 kg
<b>Packaging dimensions</b>	470 × 380 × 336 mm	470 × 380 × 336 mm	470 × 380 × 336 mm	470 × 380 × 336 mm	470 × 380 × 336 mm

\* repeatability is expressed as a standard deviation from 10 weighing cycles

\*\* optional solution

\*\*\* non-condensing conditions

In accordance with type approval, the balance parameters are maintained in temperature range: +15 ÷ +35 °C.

	WLC 6/F1/K WLC 6/F1/R	WLC 12/F1/K WLC 12/F1/R	WLC 30/F1/K WLC 30/F1/R	WLC 60/C2/K WLC 60/C2/R	WLC 120/C2/K WLC 120/C2/R
<b>Maximum capacity [Max]</b>	6 kg	12 kg	30 kg	60 kg	120 kg
<b>Minimum load</b>	5 g	—	—	50 g	—
<b>Readability [d]</b>	0.1 g	0.2 g	0.5 g	1 g	2 g
<b>Verification scale interval [e]</b>	1 g	—	—	10 g	—
<b>Tare range</b>	-6 kg	-12 kg	-30 kg	-60 kg	-1 20 kg
<b>Repeatability*</b>	0.1 g	0.2 g	0.5 g	1 g	2 g
<b>Linearity</b>	±0.2 g	±0.6 g	±1.5 g	±2 g	±6 g
<b>Stabilization time</b>	3 s	3 s	3 s	3 s	3 s
<b>Adjustment</b>	—	external (2 stages)	external (2 stages)	—	external (2 stages)
<b>Verification</b>	Yes	—	—	Yes	—
<b>OIML Class</b>	II	—	—	II	—
<b>Display</b>	LCD (with backlight)	LCD (with backlight)	LCD (with backlight)	LCD (with backlight)	LCD (with backlight)
<b>Indicator fastening</b>	1 m cable connection (K), direct connection (R)	1 m cable connection (K), direct connection (R)	1 m cable connection (K), direct connection (R)	2.5 m cable connection (K), direct connection (R)	2.5 m cable connection (K), direct connection (R)
<b>Keypad</b>	5 keys	5 keys	5 keys	5 keys	5 keys
<b>Protection class</b>	IP 43	IP 43	IP 43	IP 43	IP 43
<b>RS 232</b>	1	1	1	1	1
<b>RS 232**</b>	1	1	1	1	1
<b>Power consumption</b>	6 W	6 W	6 W	6 W	6 W
<b>Power supply</b>	100 ÷ 240 V AC 50 ÷ 60 Hz / 12 V DC + battery	100 ÷ 240 V AC 50 ÷ 60 Hz / 12 V DC + battery	100 ÷ 240 V AC 50 ÷ 60 Hz / 12 V DC + battery	100 ÷ 240 V AC 50 ÷ 60 Hz / 12 V DC + battery	100 ÷ 240 V AC 50 ÷ 60 Hz / 12 V DC + battery
<b>Operation time on batteries</b>	10 h	10 h	10 h	10 h	10 h
<b>Operating temperature</b>	+15 ÷ +30 °C	+15 ÷ +30 °C	+15 ÷ +30 °C	+15 ÷ +30 °C	+15 ÷ +30 °C
<b>Atmospheric humidity**</b>	10 ÷ 85% RH	10 ÷ 85% RH	10 ÷ 85% RH	10 ÷ 85% RH	10 ÷ 85% RH
<b>Weighing pan dimensions</b>	300 × 300 mm	300 × 300 mm	300 × 300 mm	400 × 500 mm	400 × 500 mm
<b>Weighing device dimensions</b>	445 × 300 × 70 mm	445 × 300 × 70 mm	445 × 300 × 70 mm	547 × 502 × 103 mm	547 × 502 × 103 mm
<b>Net weight</b>	5.2 kg	5.2 kg	5.2 kg	12.5 kg	12.5 kg
<b>Gross weight</b>	6 kg	6 kg	6 kg	15 kg	15 kg
<b>Packaging dimensions</b>	570 × 390 × 170 mm	570 × 390 × 170 mm	570 × 390 × 170 mm	720 × 580 × 220 mm	720 × 580 × 220 mm

\* repeatability is expressed as a standard deviation from 10 weighing cycles

\*\* optional solution

\*\*\* non-condensing conditions

In accordance with type approval, the balance parameters are maintained in temperature range: +15 ÷ +35 °C.

# Dimensions

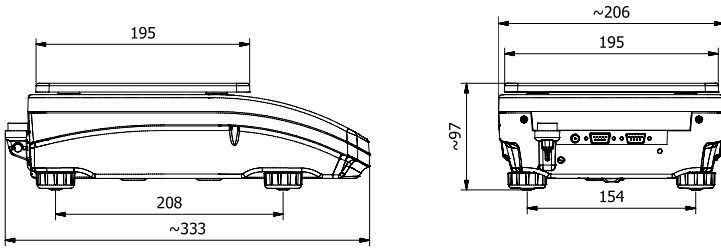

WLC A2

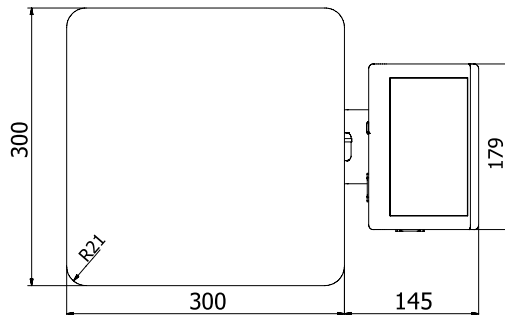
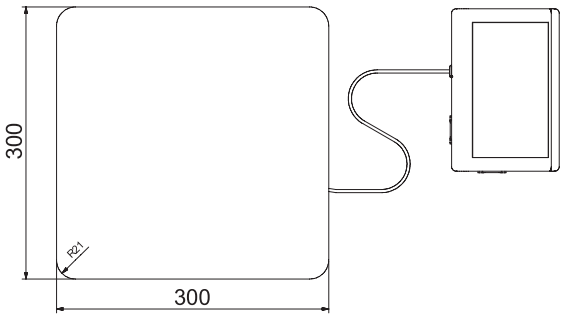
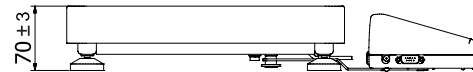
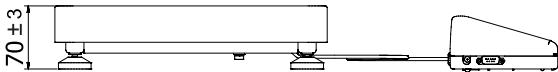

WLC F1/K

WLC F1/R

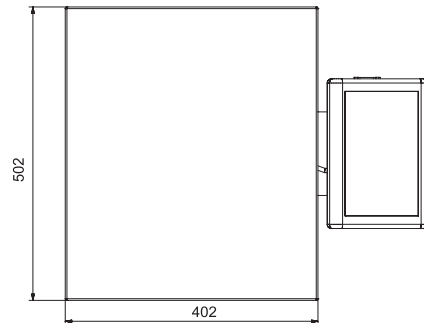
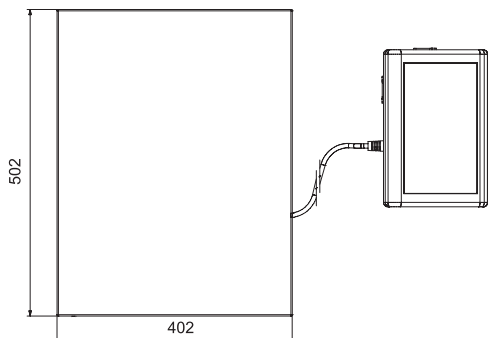
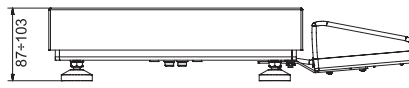
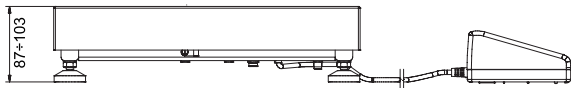

WLC C2/K

WLC C2/R

## Accessories

---

### **Weighing Tables**

- granite antivibration table

### **Professional Weighing**

- under-hook weighing rack

### **Peripheral Devices**

- Epson dot matrix printer
- WD-4/4 LCD display

### **Cables, Converters**

- P0108: RS 232 cable (balance-computer)
- P0151: RS 232 cable (balance - Epson printer)
- KR-01 converter
- AP2-1 power loop output

### **Remaining Accessories**

- suitcase for WLC/A1-A2

## Dedicated Software

---

### **R-LAB**

- collecting measurements
- carrying out statistical analysis of measurements
- customized graphs and reports

### **LabView Driver**

- operation of RADWAG balances in LabView environment

### **Scale editor**

- Software designed to enable change of parameters in the PUEC/31 indicator.

### **RAD KEY**

- Establishing cooperation between a weighing instrument and a computer

### **R. Barcode**

- The basic function software is presentation of the data sent by barcode scanners connected to PC via USB or RS232

### **Radwag Development Studio**

- presentation of functions (and subfunctions) of communication protocol (Common Communication Protocol)
- possibility of connection with weighing equipment on which each function is carried out,
- library with mass control, contained within the development environment
- complete documentation of the communication protocol
- set of user manuals for different solutions addressed for programmers employed in companies using RADWAG-manufactured weighing equipment

### **RADWAG Connect**

- establishing communication with all balances, scales and weighing modules using Common Communication Protocol
- communication via local network,
- support of basic functions
- auto searching for devices
- connecting with few devices simultaneously, swapping between them
- clear list of connected platforms
- record of measurements in the program,
- export of carried out measurements to CSV file,
- work performed using freely selected device with Windows 10 operating system